

# BOCCA

## OWNER'S MANUAL

Two Seat Golf Cart



*The charging cord is located under the front seat under the passenger side.*

### CUSTOMER SERVICE

 24445 Northwestern Hwy, Suite 101 • Southfield, MI 48075



833-953-1758



sales@pdgmail.com

# OWNER'S MANUAL

Two Seat Golf Cart

## BEFORE OPERATION

### WARNING

Read this manual carefully before operating the vehicle.

Before operating this vehicle, the operator must have read and have an understanding of all the instructions for safe operation, and all portions of the vehicle.

**PLEASE KEEP THIS MANUAL**  
so that it can be easily  
referenced when needed.

**THE PRODUCT AND SPECIFICATIONS MAY BE SUBJECT TO  
CHANGE WITHOUT NOTICE.**

## SPECIFICATIONS: LIFTED CART

LxDxH	L 95-in x D 48-in x H 74-in	
Wheelbase	Front Tires 35.5" Back Tires 39.4"	Wheelbase 66.9
Ground Clearance	3.94"	
Dry Weight	1,191 lbs. (with batteries)	
Front Tire	215 x 35-12 158kPa or 23PSI	
Rear Tire	215 x 35-12 158kPa or 23PSI	
Front Brake	215 Diameter	
Rear Brake	230 Diameter	
Front Suspension	Dual A-Arm Wishbone Suspension	
Rear Suspension	Trailing Arm Independent Suspension	
Motor	AC Motor 48V5KW/YDQ5-4-13580	
Battery Options	4-EVF-150Ah Lead Acid	

## WEIGHT LIMIT

- Without affecting the normal running of the two-seater Golf Cart, the maximum load is 700 lbs.

---

### CUSTOMER SERVICE

Mon – Fri, 8:00 a.m. – 4:00 p.m. EST • 833-953-1758 •  
24445 Northwestern Hwy, Suite 101 • Southfield, MI 48075

## TABLE OF CONTENTS

---

<b>Before Operation</b> . . . . .	2
Specifications . . . . .	3
Weight Limit . . . . .	3
Customer Service . . . . .	3
<b>01 Introduction</b> . . . . .	6
Important Safety Instructions . . . . .	7
<b>02 Safety Alert</b> . . . . .	8
<b>03 Safety Warning</b> . . . . .	9
<b>04 Pre-Ride Inspection</b> . . . . .	11
Pre-Transport Check List. . . . .	12
<b>05 Operation Warnings</b> . . . . .	13
<b>06 Controls, Parts, and Functions</b> . . . . .	14
Player Features. . . . .	15
Golf Ball/Club Washer . . . . .	15
Cooler . . . . .	15
Sand Bottle. . . . .	15
Turn Signal Lever Instructions . . . . .	16
Accelerator / Brake Pedal . . . . .	17
1. Brake Pedal . . . . .	17
2. Accelerator Pedal . . . . .	17
Engagement Switch . . . . .	18
Electromagnetic Brake . . . . .	19
Seat Belts. . . . .	20
Charging . . . . .	21
Operating Instructions for Cart LED Lights. . . . .	22

<b>07 LCD Screen</b>	24
Wiring	24
Key Description	24
Main Menu	26
Apple CarPlay & Android Auto	26
Settings	26
Radio Mode	27
USB	31
Bluetooth Audio	32
Bluetooth Phone	34
<b>08 Maintenance</b>	38
Periodic Maintenance Schedule	39
Inspection Schedule	40
Lubrication Recommendations	42
Periodic Maintenance Record	43
Wheel Nut Torque Specifications	44
Brakes	45
Front Brake	45
Rear Brake	46
Checking the Brake Fluid Level	46
Recommended Brake Fluid	46
Recommended Brake Fluid: DOT 4	46
Wheels and Tires	47
Lights	47
<b>9 Troubleshooting</b>	48
Starting Failure	48
Lights and Meter are Not Working Properly	48
Poor Charging Performance	49
Poor Braking Effect	49
<b>10 Warranty</b>	50

Congratulations on the purchase of your BOCA Golf Cart (“Golf Cart” or “Vehicle”). This is an environmentally friendly vehicle, aerodynamically designed and loaded with extra features.

We take great pride in providing you with this product that has been manufactured to the highest standards of quality and performance.

This manual is intended to provide the owner and operators of the vehicle with an overview of operating and included features. It also contains information on care and maintenance.

Please read the information carefully. It will help you to understand all safety warnings and proper use of the vehicle. Be sure to understand all warnings and instructions before operating the vehicle.

After reading, please keep this information for future reference.

If you have any questions regarding this material, please contact our customer service team and they will be sure to assist you.

## IMPORTANT SAFETY NOTICE

- Review all local, state and federal/national laws and regulations before choosing where to operate this vehicle. Ensure that you understand and follow all riding laws and requirements.
- Do not make any modifications to the vehicle.
- Failure to follow these warnings increases the possibility of accidents leading to Death or Serious Injury!

# IMPORTANT SAFETY INSTRUCTIONS



**SERIOUS INJURY OR DEATH CAN RESULT IF YOU DO NOT CAREFULLY FOLLOW THESE INSTRUCTIONS.**

- Read this manual and all labels carefully and follow the operating procedures described.
- This vehicle is not designed to carry more passengers than seats with seat belts will allow.
- Ensure the driver and all passengers are properly wearing seat belts.
- Intended use is for ages 16 and up.
- There is a risk of rollover under certain conditions. Uneven terrain or slopes which pitch the vehicle sideways, turning too fast or sharp, or a combination of conditions increase the risk of tip over.
- Never consume alcohol or drugs before or while operating this vehicle.
- Maintain a speed which is proper for operating conditions.
- Ensure your vehicle is in proper operating condition.
- Keep arms and legs inside the vehicle during operation. Failure to do so may result in injury or death.
- Keep both hands on the steering wheel when driving.
- It is recommended to have the vehicle checked by an authorized dealer if it has been involved in an accident.
- Check the terrain before you start down any hill. The driver should avoid going down a hill at an angle which may cause tipping.
- Be cautious of skidding or sliding. When on a slippery surface, go slowly and be cautious to reduce the chance of skidding or sliding out of control.
- Avoid operating the vehicle in deep water. Maintain a slow and steady forward pace if driving through shallow water. Test your brakes after leaving water.
- When proceeding safely in reverse, go slowly. Avoid turning at sharp angles.
- Maintain proper tire pressure as described in this manual.



**WARNINGS ALERT YOU OF THE POTENTIAL FOR PERSONAL INJURY OR LOSS OF LIFE. READ AND OBSERVE ALL WARNINGS IN THIS MANUAL CAREFULLY!**

## **WARNING**

Indicates a potential hazard which could result in severe injury or death.

## **CAUTION**

Indicates a potential hazard which may result in minor personal injury or damage to the vehicle.



**WARNING DECALS** have been placed on the vehicle for your protection. Read and follow the instructions on each label carefully. In the event any label becomes illegible or comes off, contact customer service for a replacement.

## ⚠️ WARNING ⚠️

**IMPROPER USE OF THIS VEHICLE CAN RESULT IN SEVERE INJURY OR DEATH.**

### **BE PREPARED**

- Fasten seat belts.
- Each rider must be able to sit back against the seat.
- Keep feet flat on the floor on foot rests, and both hands on the steering wheel or handrails (where equipped).
- Stay completely inside the vehicle.

### **DRIVE RESPONSIBLY**

- Avoid loss of control and rollovers.
- Avoid abrupt maneuvers, sideways sliding, skidding, or fishtailing, and never do donuts.
- Slow down before entering a turn.
- Plan for hills, rough terrain, ruts and other changes in traction and terrain.
- Avoid side hilling (riding across slopes).

### **BE SURE RIDERS PAY ATTENTION AND PLAN AHEAD IF YOU THINK THE VEHICLE MAY TIP OR ROLL, REDUCE YOUR RISK OF INJURY:**

- Keep a firm grip on the steering wheel or handrails and brace yourself.
- Do not put any part of your body outside the vehicle for any reason.

### **REQUIRE PROPER USE OF THE VEHICLE.**

#### **DO YOUR PART TO PREVENT INJURIES:**

- Do not allow careless or reckless driving.
- Make sure operators are at least 16 years old and have a valid driver's license.
- **NEVER LET PEOPLE DRIVE OR RIDE AFTER USING DRUGS OR ALCOHOL.**
- **DO NOT ALLOW OPERATION ON PUBLIC ROADS** (unless designated for off-highway vehicle access). Collisions with cars and trucks can occur.
- Do not exceed seating capacity.

Locate and Read Owner's Manual. Follow All Instructions and Warnings.

## ⚠️ WARNING ⚠️

- Charge the battery every month
- Charge the battery after use
- Stop charging batteries when the charging indication light becomes green
- Charge should not exceed 10 hours

## SAFETY WARNING (cont.)

### ⚠ WARNING ⚠

Improper tire pressure can cause this vehicle to be difficult to control, resulting in serious personal injury or death.

Always keep tire pressure within the specified range.

#### TIRE PRESSURE

- All Wheels: 20 psi (137.8 kPa)

### ⚠ WARNING ⚠

Do Not Exceed 100 lbs / 44 kg  
for Golf Bag Storage Area.



Tipping  
Hazard.



NEVER ALLOW PASSENGER(S) TO  
RIDE IN AREAS DESIGNATED FOR  
GOLF BAG STORAGE.

Always Secure Golf Bags in  
Golf Bag Storage Area Using the  
Strap(s) Provided to Ensure  
Bags Do Not Fall From the Cart  
During Operation.



### ⚠ WARNING ⚠

The roof frame cannot protect the occupants  
in all accidents, including rollover.

# PRE-RIDE INSPECTION

## WARNING

For safe operation, inspect your vehicle before riding to ensure it is in proper working order or severe injury or death could result.

- **TIRES:** Check condition and pressures.
- **BATTERY:** Check for battery abnormalities. Ensure the wiring is secure and the terminal is protected.
- **BRAKES:** Check fluid level, operation, adjustment.
- **BRAKE PEDAL:** Check for correct brake pedal free play. If the brake pedal free play is incorrect, have an authorized dealer adjust it. Check the operation of the brake pedal. It should move smoothly and there should be a firm feeling when the brakes are applied. If not, have the vehicle inspected by an authorized dealer.
- **BRAKE FLUID LEAKAGE:** Check to see if any brake fluid is leaking out of the pipe joints or the brake fluid reservoir. Apply the brakes firmly for one minute. If there is any leakage, have the vehicle inspected by an authorized dealer.
- **BRAKE FLUID LEVEL:** Check the brake fluid level.  
Add fluid if necessary.
- **BRAKE OPERATION:** Test the brakes at slow speed after starting out to make sure they are working properly. If the brakes do not provide proper braking performance, inspect the brake system.
- **ACCELERATOR PEDAL:** Check for free operation, closing and free play.  
  
Check to see that the accelerator pedal operates correctly. It must operate smoothly and fully spring back to the idle position when released.  
  
Have an authorized dealer repair as necessary for proper operation.
- **HEADLIGHTS / TAILLIGHTS / BRAKE LIGHTS / TURN SIGNALS:** Check operation of all indicator lights and switches.

- **WHEELS:** Check for tightness of wheel nuts, axle nuts and check that axle nuts are secured by cotter pins. Check balance / damage / run out. Have an authorized dealer repair / replace, if necessary. Check bearing assemblies for looseness / damage. Have an authorized dealer replace if damaged.
- **STEERING:** Check for free operation noting any unusual looseness in any area. Park on level ground. Turn the steering wheel right and left. Check for excessive free play, abnormal noises, or a rough feeling. Have an authorized dealer repair as necessary for proper operation.
- **SEAT BELTS:** Check for proper operation and belt wear. Make sure that seat belts are not frayed or damaged. The seat belt must move smoothly when pulled out and retract on its own when released. The latch plate should click securely into the buckle and release when the release button is pushed firmly. Clean off any dirt or mud which could affect operation. Have an authorized dealer repair as necessary for proper operation.

## PRE-TRANSPORT CHECK LIST

- Turn off the Ignition.
- Close and secure the Golf Cart windshield.
- Engagement switch should be in the middle OFF position.
- Golf Cart mirrors should be turned in.
- The floor mat should be folded and stored under the seat or within your cab.
- Your trailer should be “road ready” and rated to carry this load size and weight.

# OPERATION WARNINGS

POTENTIAL HAZARD	WHAT CAN HAPPEN	HOW TO AVOID THE HAZARD
Electrical Shock.	When working on any electrical component while the Vehicle's power is on, there is a risk of electric shock that could cause serious injury or death.	Ensure the Engagement Switch is in the "OFF" position before working on any electrical components of the Vehicle.
Getting electrical components wet can cause damage to the Vehicle or cause serious injury or death.	Washing the Vehicle with excessive amounts of water can allow water to get into the battery compartment or compartments with internal wiring. This can cause short circuits to the wiring and the potential for fires.	Do not wash the Vehicle with excessive amounts of water. To clean the Vehicle, use a damp cloth and avoid contact with the battery compartment or any wiring.
Not wearing seat belts or wearing seat belts improperly.	Operating the Vehicle without properly wearing a seat belt increases the risk of serious injury or death.	Always wear your seat belt when riding in the vehicle.  Ensure the seat belt is securely fastened across your hips and is latched properly.
Using improper equipment to charge the battery.	Overcharging the battery can cause permanent damage to the battery and creates a risk of the battery exploding leading to serious injury or death.	Charge using the specified power supply and plug. Disconnect the power supply when the charging indicator is green. If the charging indicator, charging socket or power cord is faulty and cannot be charged, please contact Customer Service.
Operating the Vehicle under the influence of alcohol or drugs.	Operating the Vehicle under the influence of drugs or alcohol impairs judgment and reaction time, which could lead to serious injury or death.	Never consume drugs or alcohol before or during operation of the Vehicle.

# CONTROLS, PARTS & FUNCTIONS

## Dashboard Switches & Features:

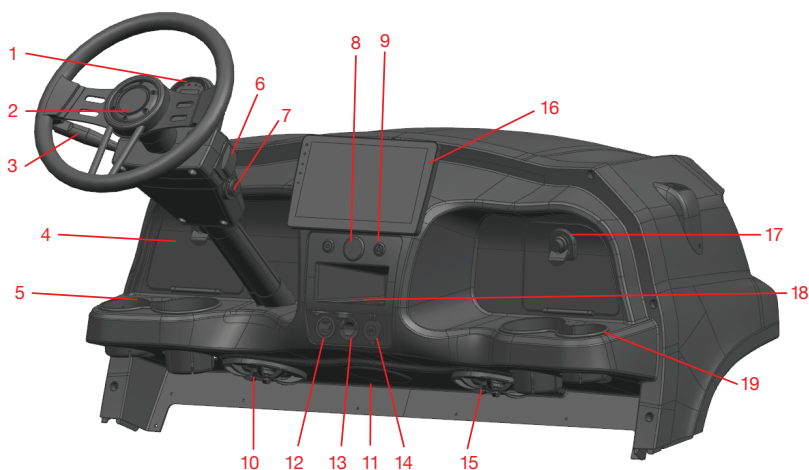

- |                                 |                                 |
|---------------------------------|---------------------------------|
| 1. Speedometer                  | 11. Horn Cover                  |
| 2. Steering Wheel               | 12. USB & TYPE-C Charging Ports |
| 3. Turn Signal Lever and Horn   | 13. 12V Auxiliary Power Outlet  |
| 4. Driver Safety Lock Box       | 14. Port                        |
| 5. Driver Cup Holder            | 15. Right Front Speaker         |
| 6. Forward/Reverse Drive Switch | 16. LCD Screen                  |
| 7. Ignition                     | 17. Passenger Safety Lock Box   |
| 8. Embedded Clock               | 18. Wireless Charger            |
| 9. Hazard Switch                | 19. Passenger Cup Holder        |
| 10. Left Front Speaker          |                                 |

# PLAYER FEATURES



## ADDITIONAL GOLF CART FEATURES

### **GOLF BALL / CLUB WASHER:**

**Two Tanks:** Two separate tanks for cleaning golf clubs and for cleaning golf balls. Fill the tanks with clean water. Strong and durable bristles are included to clean off all dirt.

**T-Drain Plug:** Pull the plug to drain the dirty water.

**COOLER:** Made with high-quality materials. The cooler is strong, portable, lightweight and durable and can withstand the rigors of the golf course. The perfect size cooler box for easy use. The lid is secure to ensure the lid won't open while driving the golf cart on the course. This item does not impede entry or exit, interfere with vehicle operation, or impair vision.

**SAND BOTTLES:** The sand bottles are designed with a curved collar to ensure it doesn't pour or leak. The design also prevents rainwater from entering. These sand bottles are equipped with a handle to hold the bottle more conveniently and comfortably. Sand bottles are made with ABS plastic to ensure its durability & a long service life.

# TURN SIGNAL LEVER INSTRUCTIONS

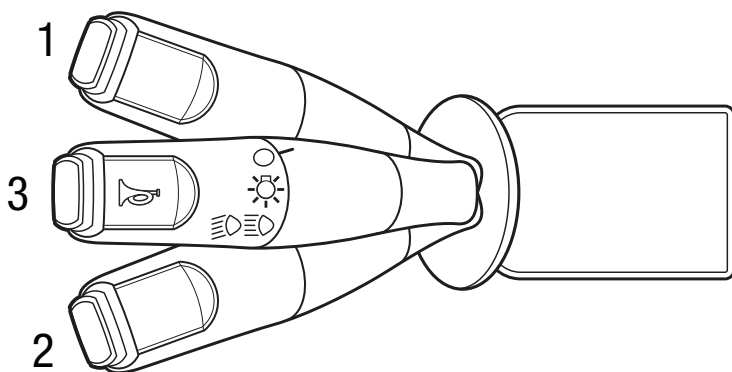
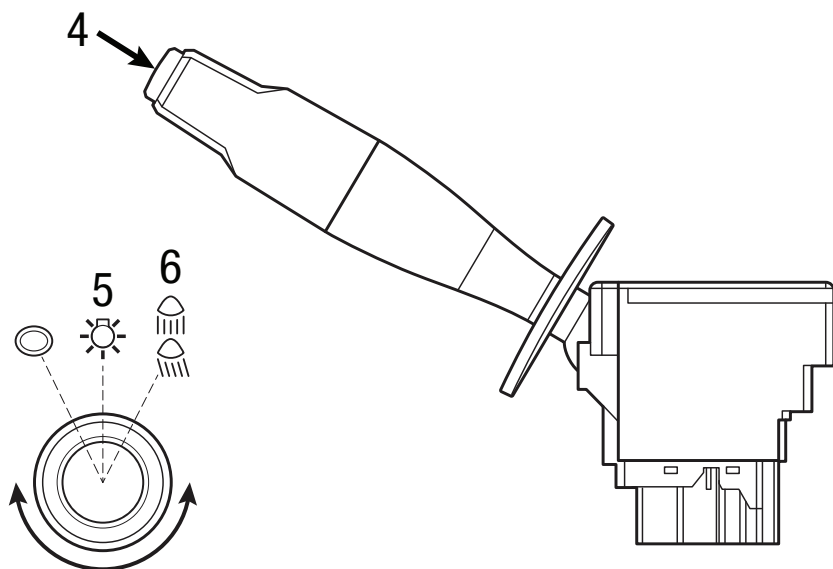

1. Right Turn Signal
2. Left Turn Signal
3. Signal Off
4. Horn
5. Running Lights
6. Brights

# ACCELERATOR / BRAKE PEDALS

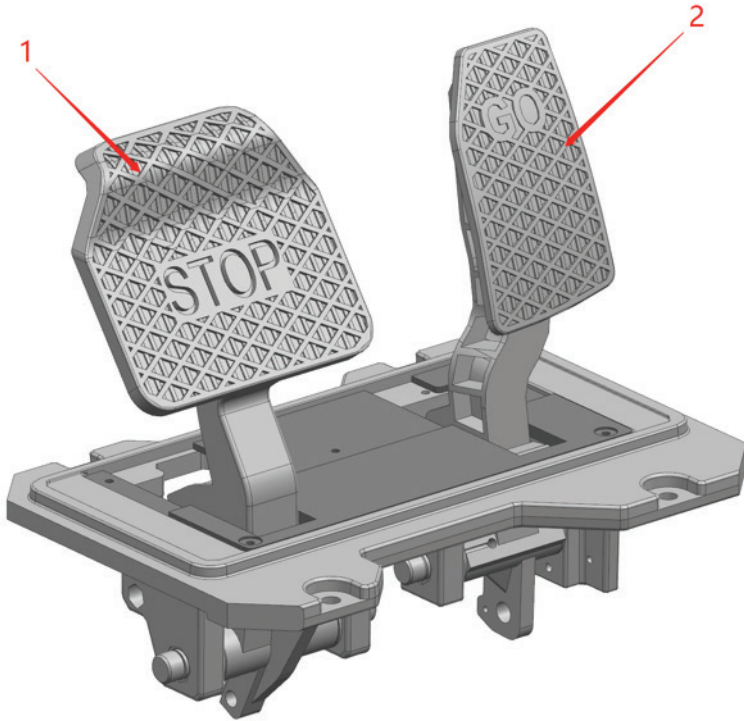

1. **BRAKE PEDAL:** Before starting the vehicle, test the brake pedal for smooth operation by pressing down and releasing to ensure it returns to the resting position. During operation, press down on the brake pedal to slow the vehicle down or come to a complete stop.
2. **ACCELERATOR PEDAL:** Check the accelerator pedal before starting the vehicle to ensure smooth operation. Apply pressure to the pedal and release making sure the pedal returns to the initial resting position without any obstruction. During operation, press down on the accelerator pedal to increase speed.

## **WARNING**

**Obstruction of the Brake or Accelerator pedals could cause the Vehicle to not stop or start as intended. This leads to a risk of losing control of the Vehicle causing the risk of serious injury or death.**

# ENGAGEMENT SWITCH

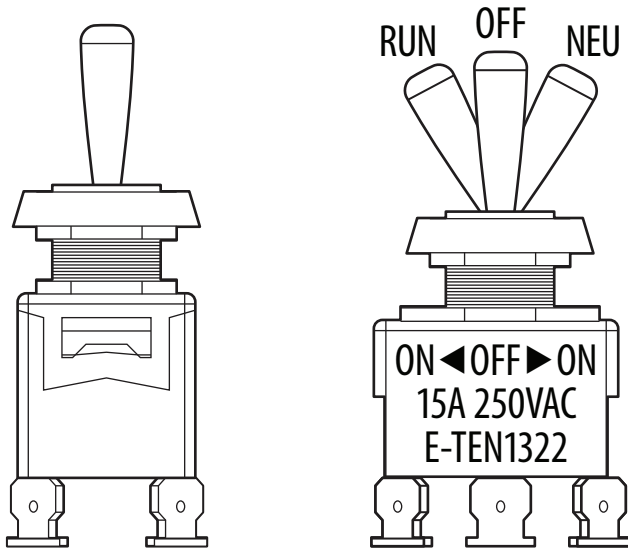

The Engagement Switch is located under the passenger side of the middle seat bench.

**RUN:** When engaged, the cart will have auto wheel lock engaged and run normally when you turn the ignition on.

**OFF:** When engaged, the auto wheel lock is engaged and the power to the cart is turned off. This setting should always be used when working on the cart.

**EMB:** When engaged, the cart will release the auto wheel lock and there will be no power to the cart. The cart will roll if the brake is not engaged. The cart should always be on a flat surface with the wheels blocked when in neutral.

# UNLOCKING THE ELECTROMAGNETIC BRAKE WITHOUT POWER

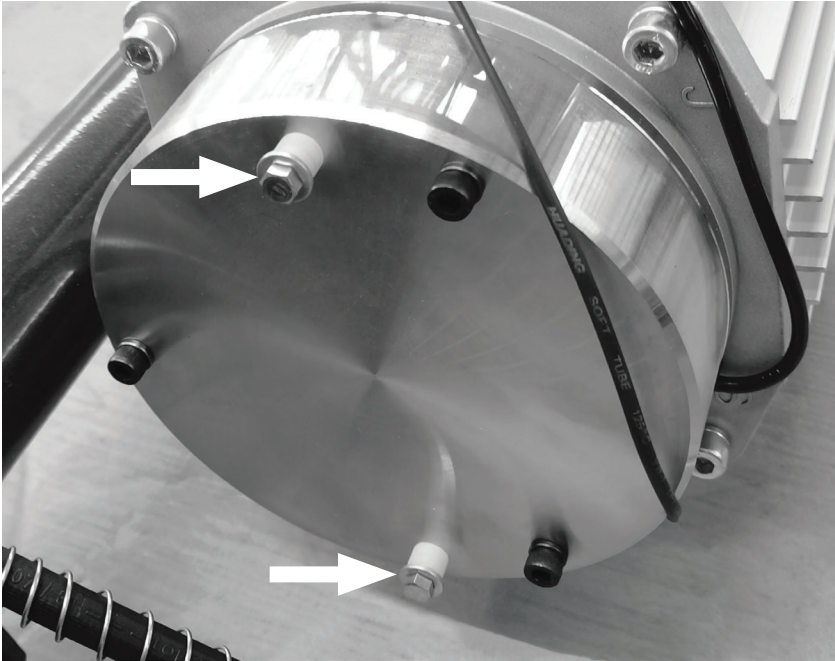

If you experience a sudden power outage and need to move your cart, you should tighten the two silver bolts all the way down. Indicated by the two white arrows on the electromagnetic brake, as shown above.

Once you've fixed your problem and power is back on, you need to loosen those same bolts two full rotations to reactivate the electromagnetic brake.

This is found on the driver's side rear axle behind the tire.

## SEAT BELTS

The captains chairs arms come with an adjustable lock on the underside of the armrest to ensure they can lock in at the most comfortable position. To lock the armrests into position, roll the device until it tightens. To loosen, roll the device in the opposite direction.



### **To Wear the Seat Belts Properly, do the following:**

1. Hold the latch plate as you pull the belt across your lap. Make sure the belt is not twisted and is not caught on any portion of the vehicle, your clothing, or any equipment you are carrying.
2. Push the latch plate into the buckle until it clicks. Pull up on the latch plate to make sure it is secure.
3. The seat belts should be positioned low on the hips.
4. To release the buckle, firmly press the release button.

# CHARGING

There is a charging indicator on the dashboard, indicating the remaining power range. To avoid potential damage to the battery do not let the remaining battery life indicated fall below 10%.

A 110V charging cable is provided with the cart that is designed to work with the battery and charging socket. If the charging cord is lost or damaged, contact customer service for a replacement.

Before charging, check to ensure the charging port, charging cable, and socket are free of damage and are not wet to avoid potential issues when plugging in. Do not use power cords other than the unit provided with the cart to avoid potential damage to the battery.

## WHEN PLUGGED IN:

- **FLASHING RED:** Cart is charging but still under 80%
- **FLASHING YELLOW:** Charging and 80% to 99%
- **FLASHING GREEN:** 100% Charge, remove the charging cable

When the indicator light is flashing green, it indicates that the battery is fully charged, and the power cord should be unplugged to prevent overcharging the battery.

It is recommended that when the unit is not being used regularly to charge the battery at least once per month. Do not let the battery sit without charging for extended periods of time to avoid potential damage to the battery.

## OPERATING INSTRUCTIONS FOR CART LED LIGHTS

### Key operation instructions



1. Touch **FWD COLOR** to change the brightness of the LED Lights or turn off the LED Lights.



2. Touch **FWD MODE** button to switch the color of the LED Lights (only in Monochromatic mode, Colorful mode and Marquee mode).



3. Press and hold **FWD MODE** button for more than 2 seconds each time to switch the LED Lights mode cyclically: Monochromatic mode, Breathing mode, Burst mode, Music rhythm mode, Colorful mode, Marquee mode, Overlay mode, Custom mode.

### Voice Command function description

Wake up voice operation: just say “Hello, Lamp,” then you can say the function what you want to control. The microphone is located under the driver seat so try to face it when making commands before entering the cart.

If you want to end voice operation: just say “Over,” or automatically cancel voice operation after 5 seconds of no operation after wake-up.

NO.	VOICE OPERATION WORDS	SYSTEM REPLY	EXPLAIN
1	Turn on the LED Lights	Atmosphere light is on	Turn on the atmosphere light
2	Turn off the atmosphere light	Atmosphere light is off	Turn off the atmosphere light
3	Turn up the brightness	Lamp brightness increases	The brightness of LED Lights is improved
4	Turn down	Lamp brightness decreases	The brightness of LED Lights decreases
5	Brightest   Maximum brightness	Brightest	Turn the atmosphere light to the brightest
6	Darkest   Minimum brightness	Darkest	Turn the atmosphere light to the darkest
7	Brightness to one	Turn the brightness to one	Adjust the brightness of the LED Lights to one
8	Brightness to two	Turn the brightness to two	Adjust the brightness of LED Lights to two

<b>NO.</b>	<b>VOICE OPERATION WORDS</b>	<b>SYSTEM REPLY</b>	<b>EXPLAIN</b>
9	Brightness to three	Turn the brightness to three	Adjust the brightness of LED Lights to three
10	Brightness to four	Turn the brightness to four	Adjust the brightness of LED Lights to four
11	Brightness to five	Turn the brightness to five	Adjust the brightness of LED Lights to five
12	Turn to monochrome	Monochromatic mode	Switch to monochrome mode
13	Breathing mode	Breathing mode	Switch to breathing mode
14	Burst Mode	Burst mode	Switch to burst mode
15	Music rhythm mode	Music rhythm mode	Switch to music rhythm mode
16	Colorful mode	Colorful mode	Switch to colorful mode
17	Marquee mode	Marquee mode	Switch to marquee mode
18	Overlay mode	Overlay mode	Switch to Overlay mode
19	Custom mode	Custom Mode	Switch to custom mode
20	Turn to red	Red	Switch to red
21	Turn to green	Green	Switch to green
22	Turn to blue	Blue	Switch to blue
23	Turn to cyan	Cyan	Switch to cyan
24	Turn to purple	Purple	Switch to purple
25	Turn to pink	Pink	Switch to Pink
26	Turn to white	White	Switch to white
27	Turn to yellow	Yellow	Switch to yellow
28	Turn to orange	Orange	Switch to orange
29	Next   Change	Next	Switch to next color
30	Previous	Previous	Switch to previous color
31	Hurry up	Hurry up	Speed up the dynamic display effect of lamp
32	Slow down	Slow down	Slow down the dynamic display effect of lamp

## WIRING BLOCK IS BEHIND THE DASHBOARD

## KEY DESCRIPTION

## Frequency Range:

FM: 87.5-107.9 MHz AM: 530-1710 KHz

CLASS 1  
LASER PRODUCT

## WARNING

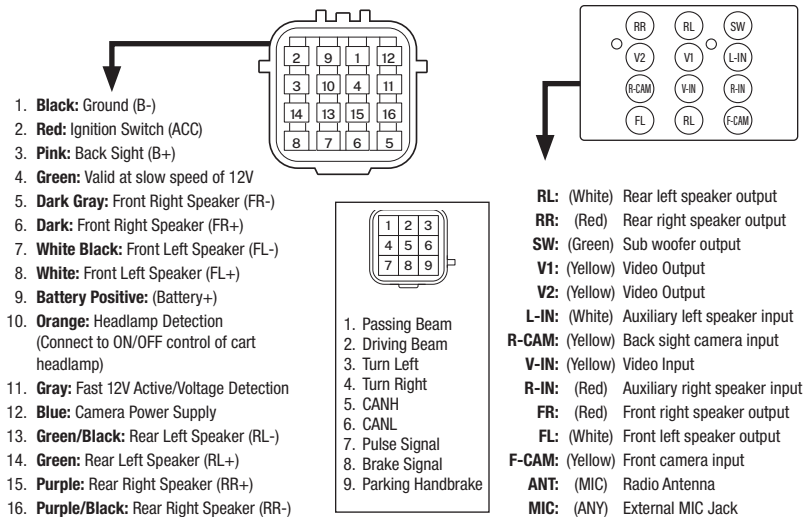
POWER SOURCE: DC 12V  
POWER CONSUMPTION: 40Wx4

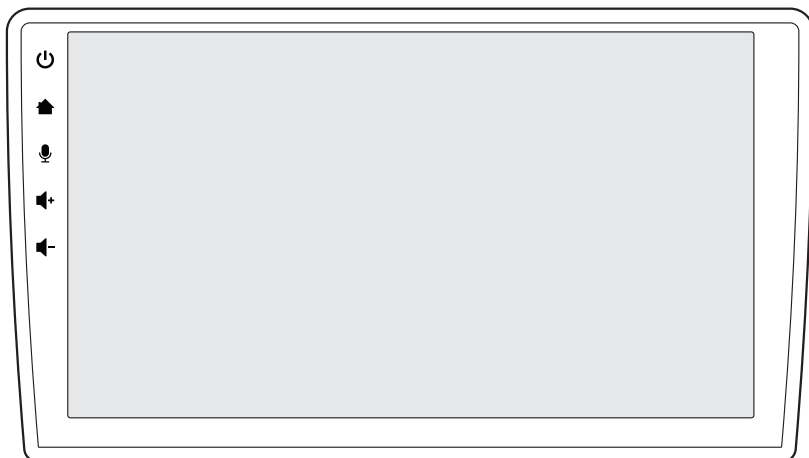

## 2.1. POWER

When the ignition switch is in the ON position, press the switch panel on the touchscreen  key to boot.

## 2.2. OFF

After the start, press & hold the power  button for 2 seconds; the screen will perform its shutdown.

**ATTENTION:** When there is noise, please briefly press the power button  to enter mute mode.

## 2.3. MAIN INTERFACE

When booting, the system will default to the home  screen.

## 2.4. MICROPHONE

When linking to the CarPlay function, you can click the microphone button  for voice control, similar to the voice assistant on an Apple or Android phone.

## 2.5. VOLUME CONTROL KEYS

This button  will increase the volume. This button  will reduce the volume.

# MAIN MENU

The Mode icon in gray means the corresponding function is not ready or proper device has not been connected. Touch the corresponding Mode icon to enter playing mode.

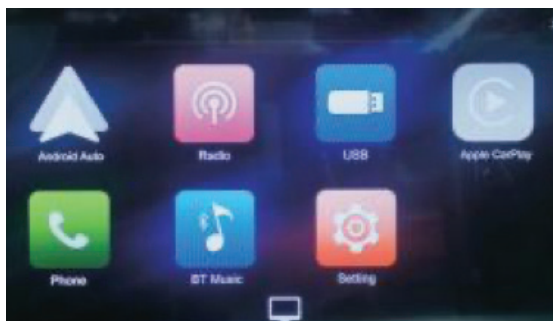

To turn off the display at any time you can press the screen saver icon.

Main Menu

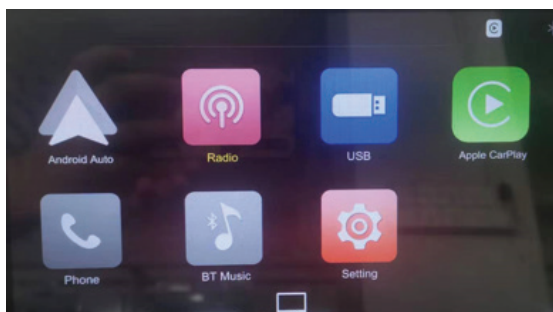

Apple CarPlay Connected

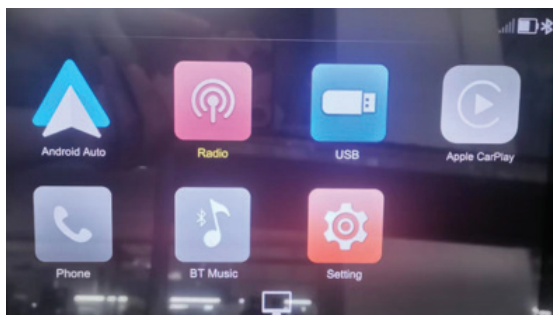

Android CarPlay Connected

## SETTINGS:

Touch the  icon to enter the Setup menu. The Setup menu includes Time Settings, Sound Settings, General Settings & Wallpaper Settings.

## TIME SETTINGS:

The Time Settings allow the user to set Date & Time.



## SOUND SETTINGS:

Below is the Sound Setting Menu.

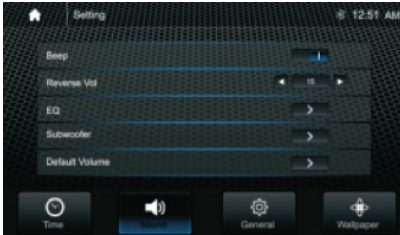

**BEEP:** Set the Beep Tone to On or Off.

**REVERSE VOL:** Adjust the music's volume when the car is put into reverse.

## EQ SETTINGS:

### BALANCE/FADER:

**LOUDNESS:** set the Loudness is ON or OFF.

Touch the “◀” or “▶” of Balance /Fader to tune for the driver and passenger preference.

The value of Balance (Left 12-Right 12) and Fader (Front 12- Rear 12).

Touch Reset to set both Balance and Fader to 0.



### 10-BAND EQUALIZER:

EQ tuning, slide the EQ bar to tune each band frequency level according to your preference.

Reset will set to factory settings.

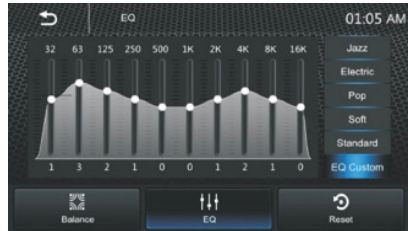

## DEFAULT VOLUME SETTINGS:

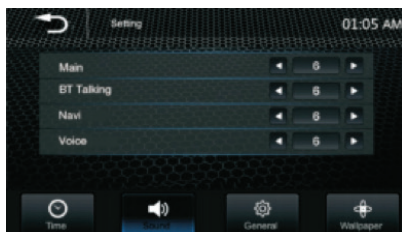

Set the Main / BT Talking / Navi / Voice default volume value.

## VOLUME CONTROL:

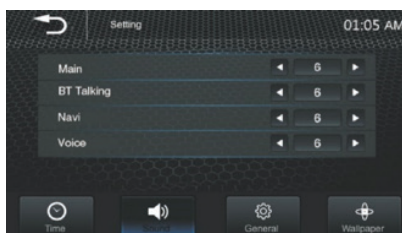

Set the Main / BT Talking /Navi / Voice default volume value.

## GENERAL SETTINGS:

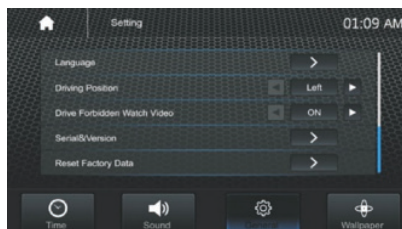
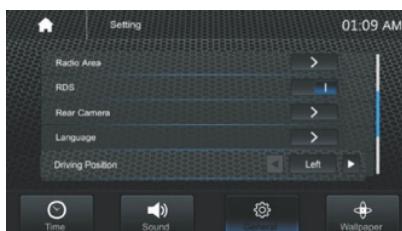
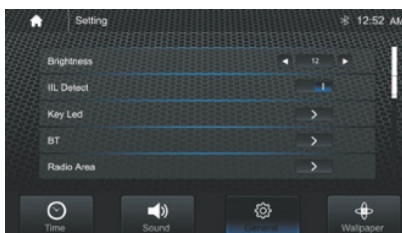

**BRIGHTNESS:** Adjust the screen's brightness from 0-15.

**ILLUMINATION DETECT:** (Auto Brightness) ON/OFF

## KEY LED:

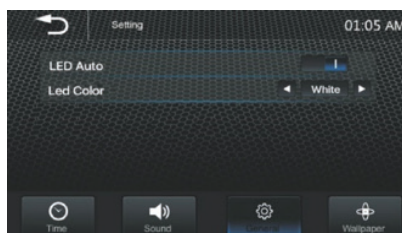

## LED AUTO – ON/OFF:

**ON:** The LED color will change automatically.

**OFF:** Choose a custom LED color for the home screen buttons.

## BT:

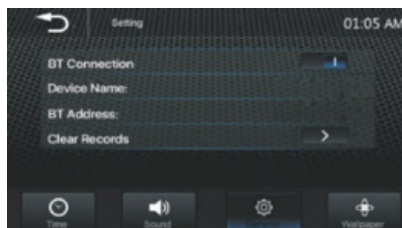

**BT:** Turn the Bluetooth Connection on and look for the Device Name to connect. After too many devices have been connected you can choose Clear Records.

## RADIO AREA:

### SELECT THE REGION:

America / Europe / Eastern Europe / Japan / Southeast Asia / Latin America / Asia / Australia.

**RDS:** ON/OFF.

### REAR CAMERA:

Parking aid line adjustment:

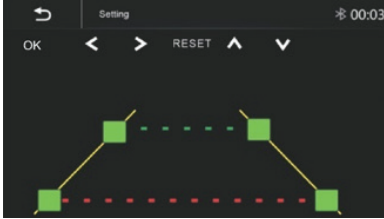

1. Select the adjust position and Touch </> / ^/∨ to adjust.
2. Touch Reset to resume the default
3. Driving Position: select the driver position  
—Is Left or Right for CarPlay
4. Drive Forbidden Watch  
Video: ON/OFF

**LANGUAGE:** Select the desired language

### SERIAL & VERSION:

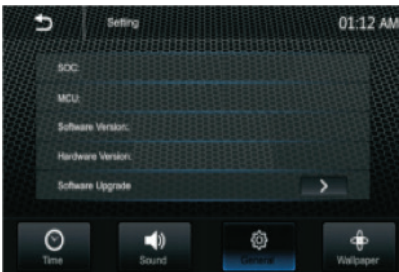

## RESET FACTORY DATA:

Once selected, the system will automatically reboot.

**WALLPAPER:** User can select the preset wallpaper for preferred background.



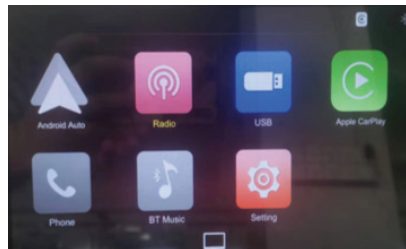

## 5.1 APPLE CARPLAY:

Plug the iPhone (iPhone 5 or later models and IOS 7.1 or above) through the lightning cable to the USB port of the source unit or turn on Bluetooth on your iPhone to pair with the source unit. The iPhone will be shown the “CarPlay” The source unit will enter the CarPlay interface, the APP that supports the CarPlay feature will be displayed on the display as shown below. Choose the desired APP by pressing it. Touch the  button to go back to the CarPlay interface.

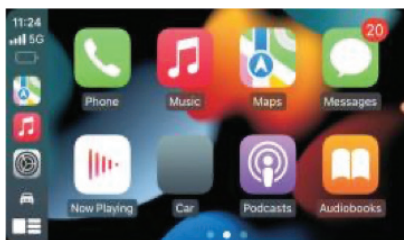



## SIRI:

In CarPlay mode, user can talk to Siri to control the CarPlay functions. Press  to start the Siri function or touch the  button for 2 seconds or the HOME button of the iPhone. Now you can talk to Siri as you would normally.

## 5.2 ANDROID AUTO OPERATIONS:

Android Auto enables you to use functions of your Android device convenient for driving. You can easily access route guidance, make calls, listen to music, etc. For details about Android Auto visit:

<https://www.android.com/auto> Or

<https://support.google.com/androidauto>.

## OPERATIONS:

1. Connect an Android device via the USB terminal. To use the hands-free function, connect the Android device via Bluetooth. When an Android device is compatible with Android Auto but is connected to USB terminal, the device will connect via Bluetooth automatically, and the Bluetooth smartphone currently connected is disconnected.
2. Unlock your Android device.
3. To enter Android Auto mode, touch the Android Auto icon on the screen.
4. You will be able to perform the operations of the Apps of the connect.

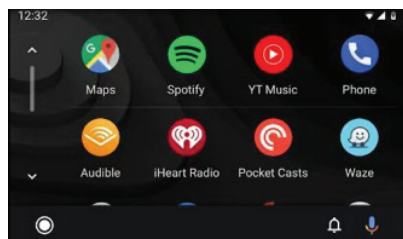
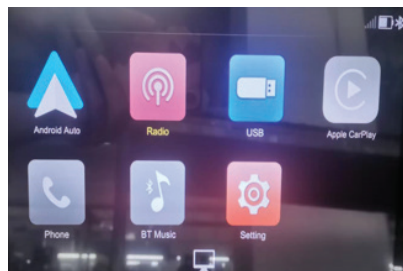

## RADIO MODE:

Touch the Radio mode icon to enter Radio.

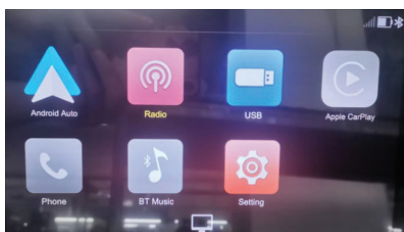

Short touch to seek-, long touch for Step-band.



Short touch to seek+, long touch for Step+

**87.50MHz**

Pre-set station, six preset save and recall stations for each.

## STORE A STATION:

1. Tune the radio to your desired station.
2. Touch and hold one of the preset stations for more than three seconds, then, the preset button will be highlighted on the screen, and the preset station will be saved.

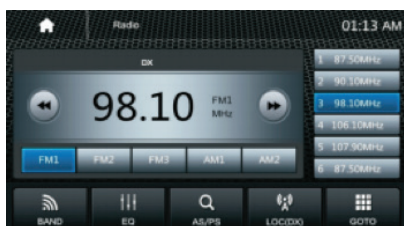

**FM1**

Touch FM1 to select FM1 Band.

**AM1**

Touch AM1 to select AM1 Band.

## TOUCH TO SELECT:

Band:

FM1>FM2>FM3>AM1>AM2



Short touch to pre-scan searching, each scanned station will be played 10s. Long touch for auto searching.



Touch to enter EQ settings.



Touch to switch LOCAL or DX.





Touch to input the tune directly.

## USB:

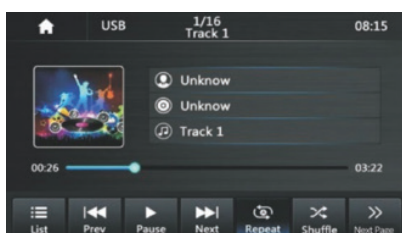
Plug the USB, the USB icon will be colorful. Touch the USB icon to enter the USB playback mode. The source unit default the play the Audio in the USB device.





 Press to list Audio, Video, Picture files in USB.

 Short press to skip previous track, long press to fast reverse.

 Play or pause button.

 Short press to skip next track, long press to fast forward.

 Press to select Repeat All > Repeat 1 > Repeat Directory.

 Press to switch Random is On or Off.

 Press to select Audio setting or set the preferred EQ of each band in custom mode.

 Touch to handle go to page for input the track number directly.

## FILE LIST BROWSING:

Touch  to browse the folder and file list of the USB device. You can select the multi-media type.

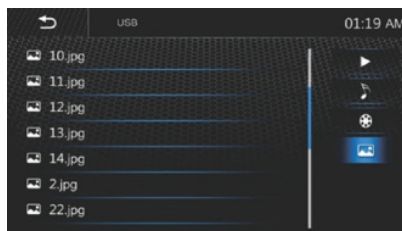

 Return to playing previous file.

 Select Audio or Music files.

 Select Movie or Video files.

 Select Picture files.

## VIDEO:

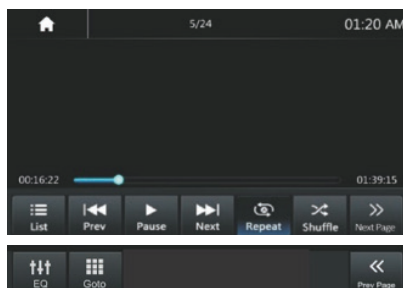

 Press to list Audio, Video, Picture files in USB.

 Short press to skip previous track, long press to fast reverse.



Play or pause button.



Short press to skip next track, long press to fast forward.



Press to switch Random to On or Off.



Press to select Repeat All > Repeat 1> Repeat Directory.



Touch to select the second page of the keypad.



Press to select Audio setting or set the preferred EQ of each band in custom mode.



Touch to handle go to page for input the track number directly.



Select the first page of the keypad.

## PICTURE:

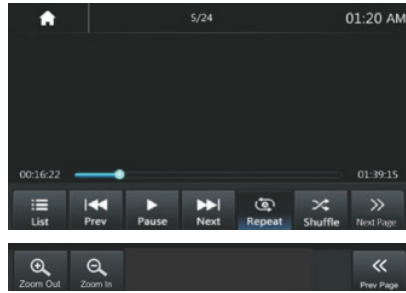

Press to Zoom Out the picture.



Press to Zoom In the picture.

## BLUETOOTH CONNECT:

Reconnect.

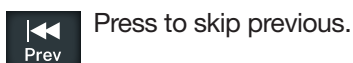
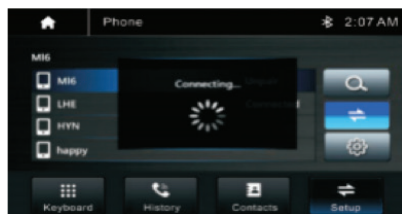
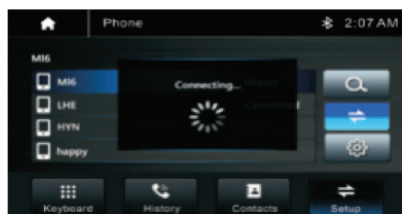
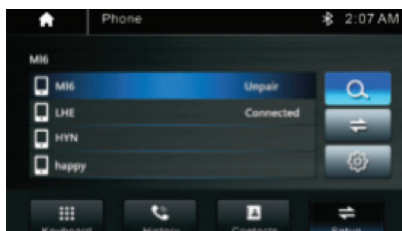

Press to skip previous.

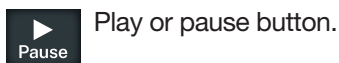

Play or pause button.

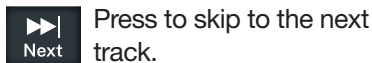

Press to skip to the next track.

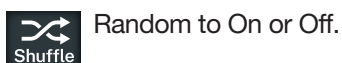

Random to On or Off.

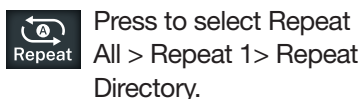

Press to select Repeat All > Repeat 1> Repeat Directory.

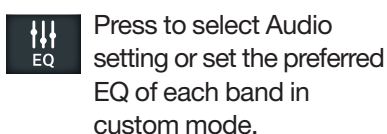

Press to select Audio setting or set the preferred EQ of each band in custom mode.

## BLUETOOTH AUDIO:

Touch the BT Audio icon to enter Bluetooth Audio playing mode. If the Bluetooth is connected, the music will be playing as shown in the following.

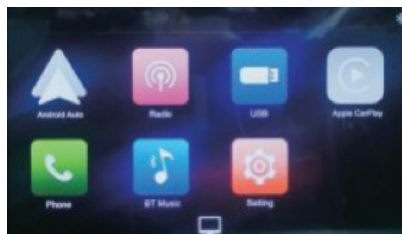

## BLUETOOTH AUDIO PLAYBACK:

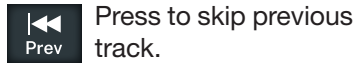
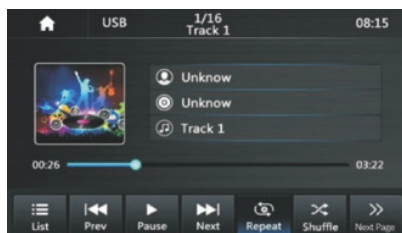

Press to skip previous track.

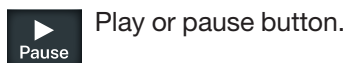

Play or pause button.

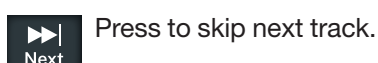

Press to skip next track.

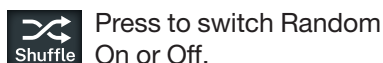

Press to switch Random On or Off.

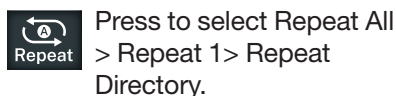

Press to select Repeat All > Repeat 1> Repeat Directory.

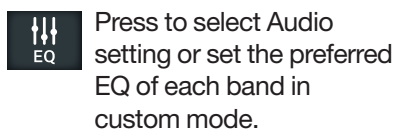

Press to select Audio setting or set the preferred EQ of each band in custom mode.

## BLUETOOTH CONNECT:

If the Bluetooth is not connected, press Reconnect The Paired Phone or Pairing to pair the new device.

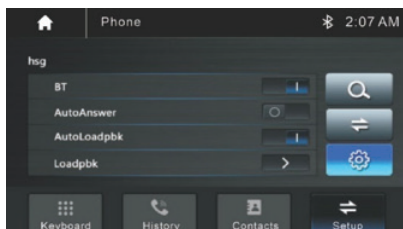
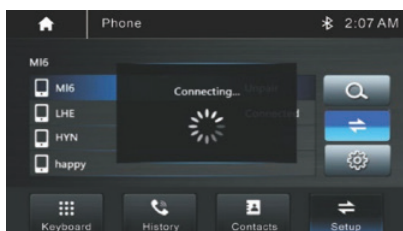
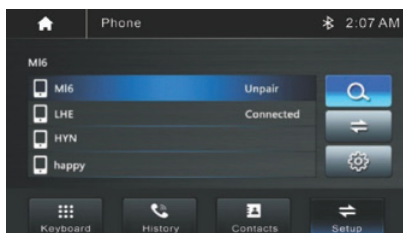

## BLUETOOTH PAIRING:

Pairing mode screen will be shown as below:

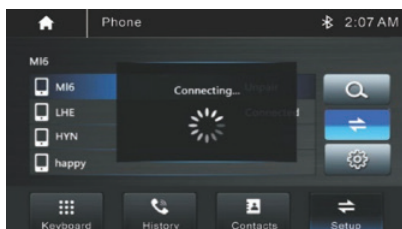
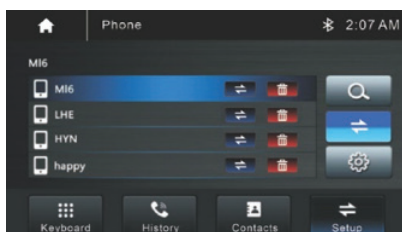

Turn On the Bluetooth of the mobile phone or Bluetooth device, you can see the CAR-KIT.

Select the CAR-KIT for pairing and connection.

## BLUETOOTH PHONE:

Touch the Phone icon in main menu to go to Phone mode. After the mobile phone is connected with the source unit via Bluetooth, use the source unit to make a call.

Please note it needs to connect to the microphone to make a phone call.

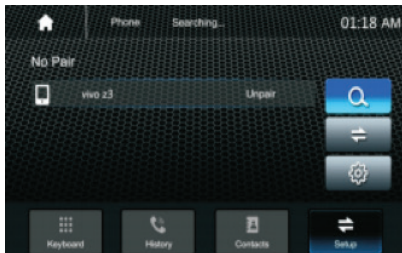
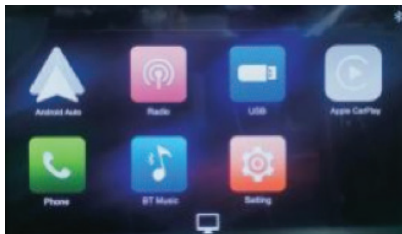

Dial pad, tap it to enter call mode.



Call logs, to show the call record, missed, received and dialed calls.



Contact, tap to show the Phone Book connected phone.



Show the usable devices.



BT Setup, tap to set auto answer and load Phone Book.





Search the available devices.



Manage the connected device.

## MAKE A CALL:

1. Touch the  icon to enter below screen.
2. Using the keypad, touch 0-9, \*, #, enter the phone number you wish to dial. If you input an incorrect number, touch the icon  on the keypad to delete the incorrect number.
3. Once the correct number appears on the screen, touch the  icon. To go to the dialing interface.

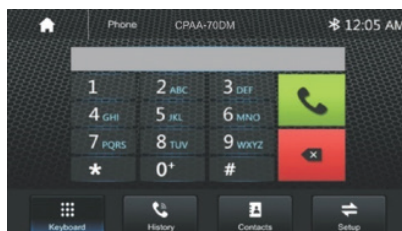

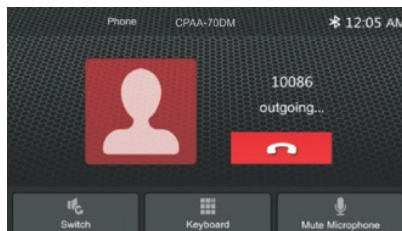

1. To end the call, touch the  icon on the screen.

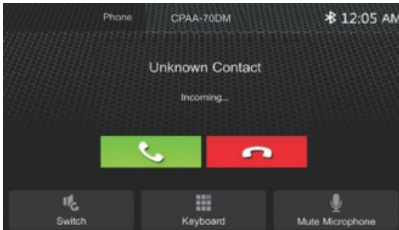

## RECEIVE AN INCOMING CALL:

The screen below will be shown if the Phone is connected with the source unit via Bluetooth during an incoming call.



Press  to answer the incoming call.

Press  to reject the incoming call.

## CALL LOGS:

Touch the icon  to display the Call combined list.

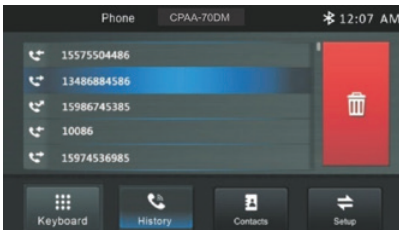

Slide the bar on the right side up and down to display call log up to 20 records.

## CONTACTS:

Touch the  icon to access the Phonebook of the connected mobile phone.

To make a call from the Phonebook, simply touch the contact name.

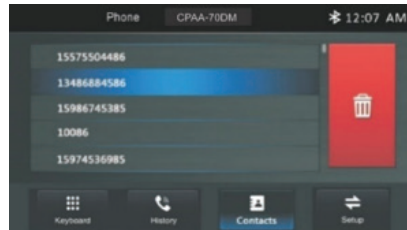

## BT SETUP:

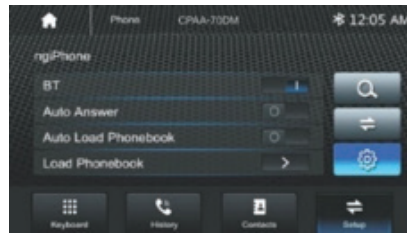

**BT:** ON/OFF-Power ON or OFF BT function.

**AUTO ANSWER:** ON/OFF, incoming call auto answer.

**AUTO LOAD PHONEBOOK:** ON/OFF – when connected to phone.

**LOAD PHONEBOOK:** Manually Load Phonebook.

1. The battery should be fully recharged after each use. Avoid letting the battery sit without charging for long periods of time to avoid loss of service life. When the vehicle is not being used regularly, fully charge the battery at least once per month.
2. Use a multimeter to check the voltage of each battery regularly. Generally the voltage of a single battery will reach more than 8.7V when fully charged. If the voltage of one of the batteries is significantly lower than the others, the battery cell may be damaged and should be inspected by a certified professional.
3. Avoid direct exposure to the sun. Sun exposure will cause the battery temperature to rise, potentially causing damage to the battery and reducing battery life. Store the cart in a cool, dry area.
4. Apply gentle pressure to the accelerator pedal when operating the vehicle to gradually increase speed. Excessive acceleration will result in large fluctuations in voltage being used which will reduce battery life over time.
5. Check battery terminals and connections for dirt or rust. Ensure they are securely fastened.
6. At 77 degrees Fahrenheit the battery capacity is 100%. Operating at lower temperatures may reduce battery life.
7. The power cable provided with the Golf Cart is specified for the battery included. Do not use charging cables other than the one provided to avoid potential damage.

# PERIODIC MAINTENANCE SCHEDULE

## **WARNING**

Due to the nature of maintenance procedures marked on the following chart, it is recommended that service be performed by a Customer Service recommended technician.

Careful periodic maintenance will help keep your vehicle in the safest, most reliable condition. Inspection, adjustment, and lubrication intervals of important components are explained in the chart below.

### **NOTE:**

Maintenance intervals are based on average riding conditions and an average vehicle speed of approximately 10 MPH.

If the vehicle isn't used for a long period of time, the monthly maintenance intervals should still be followed.

If the Vehicle is frequently operated in dirty or wet conditions, service should be performed more frequently to keep the Vehicle in good condition.

Inspect, clean, lubricate, adjust or replace parts as necessary.

### **NOTE:**

Inspection may reveal the need for replacement parts. Contact customer service to obtain original parts for replacement.

Service and adjustments are critical to maintaining optimal operation of the vehicle. If you are unfamiliar with safe service and adjustment procedures, contact customer service to identify a recommended technician for service.

# INSPECTION SCHEDULE

ITEM	MILES	WHEN	REMARKS
Brake System	Pre-ride	Pre-ride	Pre-ride inspection item
Electronic Accelerator Pedal	Pre-ride	Pre-ride	Pre-ride inspection item
Tires	Pre-ride	Pre-ride	Inspect daily, pre-ride inspection item
Front and Rear Wheels/ Hubs	Pre-ride	Pre-ride	Pre-ride inspection item
Steering	Pre-ride	Pre-ride	Inspect daily
Wheels Bearings	200 Miles	Monthly	Check for looseness/damage. Replace, if damaged. Refer to page 46
Frame Nuts, Bolts, Fasteners	Pre-ride	Pre-ride	Pre-ride inspection
Headlamp Inspection	Daily	Daily	Check operation daily. Apply dielectric grease to connector when replaced
Tail/Indicator Lamp Inspection	Daily	Daily	Check operation daily. Apply dielectric grease to socket when replaced
Transmission Oil Level	400 Miles	Monthly	Inspect monthly; change annually. Use only 85-90w GL-5 Gear Oil
Battery	Monthly	Monthly	Check/ clean Terminals. Check damage and deformation.
Brake Pad Wear	200 Miles	Monthly	Inspect periodically
Rear Gear Case Oil	2,000 Miles	Monthly	Check monthly and change annually
General Lubrication	1,000 Miles	3 Months	Lubricate all fittings, pivots, cables, etc.
Throttle Cable / Accelerator Pedal	400 Miles	Monthly	Inspect, adjust, lubricate, replace if necessary: pre-ride inspection item

# INSPECTION SCHEDULE

ITEM	MILES	WHEN	REMARKS
Steering System	1,000 Miles	6 Months	Check operation and for looseness, worn, damage, binding feeling/adjust, repair, replace if necessary. Check toe alignment/adjust if necessary
Front Axle	200 Miles	Monthly	Check for Bearing seals/looseness/damage.
Rear Axle	1,000 Miles	6 Months	Inspect bearings, Lube
Front Suspension	1,000 Miles	6 Months	Inspect-lubricate, tighten fasteners
Rear Suspension	1,000 Miles	6 Months	Inspect, tighten fasteners
Brake Fluid	4,000 Miles	24 Months	As required; Change every two years or 4,000 miles
Cart Charger	Per Use	Per Use	Check for heat/cleanliness. Avoid water entry

# LUBRICATION RECOMMENDATIONS

ITEM	LUBE REC	METHOD	FREQUENCY
Brake Fluid	DOT 4 Only	Maintain level between fill lines. See “Controls, Parts, and Functions”	As preferred; change every two years or 4,000 miles
Transmission Oil	SAE 80W/90GL5	Add proper level of 0.8 – 1.0 liter of fluid	Change annually or at 2,000 miles
Steering System	Grease	Lubricate the pivoting and sliding parts	Every 3 months or 1,000 miles
Tie rods	Grease	Grease	Semi-annually
Front Wheel Bearings	Inspect	Inspect and replace bearings if necessary	Semi-annually
Ball Joints	Grease	Inspect and Grease fittings. Replace if necessary	Semi-annually
Prop Shaft & Shaft Yoke, Spline Joint	Grease	Locate fitting and Grease	Semi-annually
Rear Axle Bearing	Grease	Grease	Every 3 months or 1,000 miles

## NOTE:

1. Please note above listed time frames should be adjusted based on driving conditions. Please increase frequency if driving in wet or dusty conditions frequently.
2. Above frequency is based on driving at an average speed of 10 MPH. If the cart is regularly being driven at higher speeds, please increase frequency.
3. Unit may have to be re-lubricated when suspension action becomes stiff or after washing unit.
4. Grease referred to above is lightweight lithium-soap grease.

# PERIODIC MAINTENANCE RECORD

Use the following chart to record periodic maintenance.

MAINTENANCE INTERVAL PERFORMED	SERVICING DATE	SERVICING DEALER OR PERSON	REMARKS
First 100 Miles			
200 Miles			
300 Miles			
400 Miles			
500 Miles			
1,000 Miles			
1,500 Miles			
2,000 Miles			

The following items should be checked occasionally for tightness; or if they have been loosened for maintenance service.

## WHEEL NUT TORQUE SPECIFICATIONS

BOLT SIZE	SPECIFICATION	
M12 x 1.25	74 ft. lbs.	100Nm

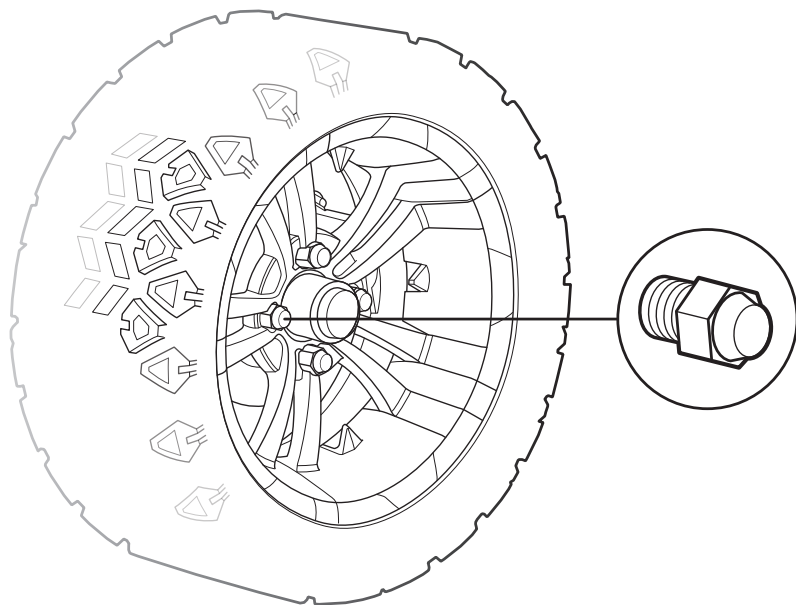

# BRAKES

## FRONT BRAKE

### WARNING

Once a bottle of brake fluid is opened, use what is necessary and discard the rest. Do not store or use a partial bottle of brake fluid. Brake fluid is hygroscopic, meaning it rapidly absorbs moisture from the air. This causes the boiling temperature of the brake fluid to drop, which can lead to early brake fading and the possibility of serious injury.

The front brake is hydraulic disc brakes which is depressing the brake pedal. These brakes are self-adjusting and require no adjustment.

The following checks are recommended to keep the brake system in good operating condition. How often they need checking depends upon the type of driving that has been done.

- Keep fluid level in the master cylinder reservoirs as described see (page 16) “Controls, Parts, and Functions.” Normal functioning of the diaphragm is to extend into the reservoir as fluid level drops. If the fluid level is low and the diaphragm is not extended, a leak is indicated, and the diaphragm should be replaced. Always fill the reservoir as indicated whenever the cover is loosened or removed to insure proper diaphragm operation. Use DOT 4 brake fluid.
- Check brake system for fluid leaks.
- Check brake for excessive travel or spongy feel.
- Check friction pads for wear, damage and looseness.
- Check security and surface condition of the disc.
- Pads should be changed when friction material is worn to  $\frac{3}{64}$ " (1.6mm) (A).

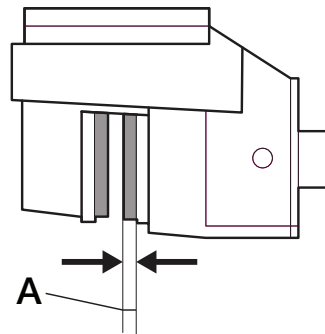

## REAR BRAKE

- The rear brake is a hydraulic disc type brake which is activated by the same pedal which activates the front brake system is self-adjusting and requires no maintenance other than periodic checks of the pads for wear.
- Pads should be changed when the friction material is worn to 3/64" (1.6mm).
- Inspect the brake disc and pad wear surface for excessive wear.

## CHECKING THE BRAKE FLUID LEVEL

Insufficient brake fluid may let air enter the brake system, possibly causing the brakes to become ineffective. Before riding, check that the brake fluid is above the minimum level mark and replenish if necessary. A low brake fluid level may indicate worn brake pads and/or brake system leakage. If the brake fluid level is low, be sure to check the brake pads for wear and the brake system for leakage. The brake fluid reservoir is located under the hood.

- When checking the fluid level, make sure the top of the brake fluid reservoir is level.
- Use only the recommended quality brake fluid. Otherwise, the rubber seals may deteriorate, causing leakage and poor braking performance.

## RECOMMENDED BRAKE FLUID: DOT 4

- Refill with the same type of brake fluid. Mixing fluids may result in a harmful chemical reaction and lead to poor braking performance.
- Be careful that water does not enter the brake fluid reservoir when refilling. Water will significantly lower the boiling point of the fluid and may result in vapor lock.
- Brake fluid may deteriorate painted surfaces or plastic parts. Always clean up spilled fluid immediately.
- Have an authorized dealer inspect the brake system if the brake fluid level goes down.

# WHEELS AND TIRES

## WARNING

Operating your Vehicle with worn, improperly inflated, non-standard improperly installed tires will affect vehicle handling which could cause an accident resulting in serious injury or death.

Follow the safeguards listed below to prevent this type of situation.

### IMPORTANT SAFEGUARDS

Improper tire inflation may affect Vehicle maneuverability.

Do not use improper tires. The use of non-standard size or type of tires may affect Vehicle handling.

Ensure the wheels are installed properly. If wheels are improperly installed it could affect vehicle handling and tire wear.

### TIRE INSPECTION

When replacing a tire always use the original equipment size and type.

# LIGHTS

## WARNING

Keep your headlights and taillights clean. Poor lighting while riding can result in an accident, causing severe injury or death.

## CAUTION

Do not service while lights are hot. Serious burns may result.

### CLEANING YOUR VEHICLE

Keeping your Vehicle clean will extend the life of various components. Avoid washing with excessive amounts of water to avoid the risk of damaging the battery or other electrical components.

# 9 TROUBLESHOOTING

## NOTE:

The following troubleshooting does not cover all possible issues. It should be helpful, however, as a guide to troubleshooting. Refer to the relative procedure in this manual for inspection, adjustment and replacement of parts. Adjustment and replacement should be done by a dealer or technician recommended by customer service.

If you are experiencing any of the issues below, please contact our customer service team with images and a description of the problem you are encountering.

## STARTING FAILURE

### LIGHTS AND METER ARE NOT WORKING PROPERLY

- Faulty DC Contactor
- Air Switch Fault or Not Open
- Cable Malfunction
- Motor Controller Malfunction
- Motor Malfunction
- Accelerator Pedal Failure or No Return
- Electronic Gear Shift Fault
- Main Switch Malfunction
- Burnt Out, Improper Connection
- Cable Malfunction
- Poor Medium and High-speed Performance
- Accelerator Pedal Output Signal Is Not Accurate
- Battery Power Shortage or Battery Malfunction
- Motor Malfunction
- Motor Controller Malfunction
- Poor Contact of Electronic Gear
- Parking Handle Not Released

# **TROUBLESHOOTING (cont.)**

## **POOR CHARGING PERFORMANCE**

- Charging Indicator Lamp Malfunction
- Car Charger Malfunction
- Charging Plug and Socket Malfunction
- Battery Connection is Not Reliable
- Battery Malfunction
- Gearbox Malfunction

## **POOR BRAKING EFFECT**

- Worn Front Hub Bearing
- Worn Brake Pad
- Worn Brake Disc
- Air In Brake Fluid
- Leaking Brake Fluid
- Faulty Master Cylinder Kit
- Faulty Caliper Seal Kit
- Loose Union Bolt
- Broken Brake Hose
- Oily or Greasy Brake Pad
- Oily or Greasy Brake Disc

# GOLF CART WARRANTY

## WARRANTY FOR NEW GOLF CART:

PDG warrants the new Golf Cart distributed by PDG and delivered hereunder will be free of defects in material and workmanship one year from date of purchase. Please note that proof of purchase and warranty registration will be required to honor this warranty. This warranty is nontransferable.

- Buyer must register unit at:  
<https://pdgpowersports.com/product-registration/>



- The Serial Number of the cart will be required for warranty registration. The serial number can be found on the driver's side rear wheel well, above the rear tire.



- **EXCEPT FOR THE FOREGOING WARRANTY AND THE WARRANTY OF CLEAR AND MARKETABLE TITLE, PDG MAKES NO OTHER REPRESENTATIONS, CONDITIONS OR WARRANTIES EXPRESS OR IMPLIED AND ALL IMPLIED WARRANTIES, INCLUDING THOSE RELATING TO MERCHANTABILITY AND FITNESS FOR A PARTICULAR PURPOSE, ARE HEREBY DISCLAIMED.**
- Purchaser shall be obligated to promptly report any failure to conform to the applicable warranty to PDG in writing within the applicable warranty period, whereupon PDG shall, at its option, correct such nonconformity by suitable repair to such Golf Cart or furnish a replacement part. PDG shall not be liable for any repairs, replacements, or adjustments to the Golf Cart or any costs of labor performed by purchaser or others without PDG's prior written approval.
- The effects of corrosion, erosion, and normal wear and tear are specifically excluded from PDG's warranty.

## VEHICLE MODIFICATION AND MISUSE:

- Misuse of the Golf Cart shall terminate the warranty. Do not install any accessory not approved by the manufacturer. Do not modify the vehicle to increase speed or power. Any modifications or installation of accessories not approved by the manufacturer can create a safety hazard and increase the risk of injury.
- The warranty will be terminated if the vehicle is modified to increase vehicle speed or power.
- The warranty may be terminated if original (or equivalent) replacement parts are not installed on the vehicle. The addition of some accessories can change the handling characteristics of the vehicle. Use only manufacturer approved accessories and familiarize yourself with their function and effect on the vehicle.
- **NOTICE:** Tire repairs are not covered under the vehicle warranty.

## LIMITATION OF LIABILITY:

- THE REMEDIES OF PURCHASER SET FORTH HEREIN ARE EXCLUSIVE.
- THE TOTAL LIABILITY OF PDG WITH RESPECT TO THIS CONTRACT OR THE GOLF CART (AND SERVICES FURNISHED HEREUNDER, IF ANY), OR FROM THE MANUFACTURE, SALE, DELIVERY, INSTALLATION, REPAIR OR TECHNICAL DIRECTION COVERED BY OR FURNISHED UNDER THIS CONTRACT, WHETHER BASED ON CONTRACT, WARRANTY, NEGLIGENCE, INDEMNITY, STRICT LIABILITY OR OTHERWISE, SHALL NOT EXCEED THE PURCHASE PRICE OF THE GOLF CART UPON WHICH SUCH LIABILITY IS BASED. PDG AND ITS SUPPLIERS SHALL IN NO EVENT BE LIABLE TO PURCHASER, ANY SUCCESSORS IN INTEREST OR ANY BENEFICIARY OR ASSIGNEE OF THIS CONTRACT FOR ANY CONSEQUENTIAL, INCIDENTAL, INDIRECT, SPECIAL OR PUNITIVE DAMAGES ARISING OUT OF THIS CONTRACT OR ANY BREACH THEREOF, OR ANY DEFECT IN, OR FAILURE OF, OR MALFUNCTION OF THE GOLF CART HEREUNDER, WHETHER BASED UPON LOSS OF USE, LOST PROFITS OR REVENUE, INTEREST, LOST GOODWILL, WORK STOPPAGE, IMPAIRMENT OF OTHER GOODS, LOSS BY REASON OR SHUTDOWN OR NON-OPERATION, INCREASED EXPENSES OF OPERATION OR CLAIMS OF PURCHASER (OR CUSTOMERS OF PURCHASER) FOR SERVICE INTERRUPTION, WHETHER OR NOT SUCH LOSS OR DAMAGE IS BASED ON CONTRACT, WARRANTY, NEGLIGENCE, INDEMNITY, STRICT LIABILITY OR OTHERWISE.
- Customer Service: (toll free: 833-953-1758) between the hours of 8:00 am and 4:00 pm EST EMAIL: sales@pdgmail.com
- Product Registration:  
<https://pdgpowersports.com/product-registration/>







**BOCA**



FOLLOW US  
ON THE WEB

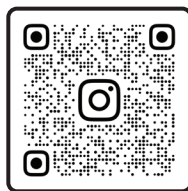

FOLLOW US ON  
SOCIAL MEDIA